

# Core Alignment Fusion Splicer Quick Reference Guide

## What's included

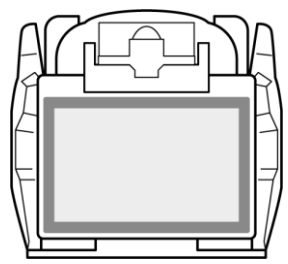

Fusion splicer

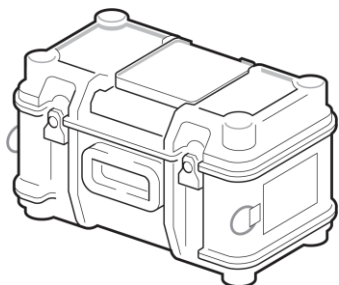

Carrying case

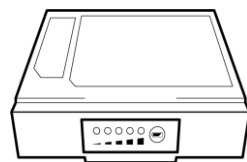

Battery pack

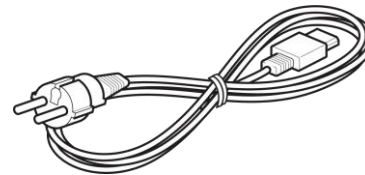

Power cord



Quick reference guide

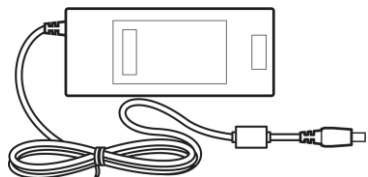

AC adapter



Electrodes

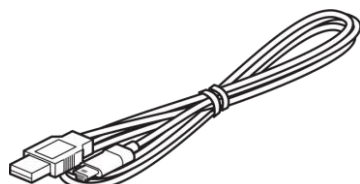

USB cable

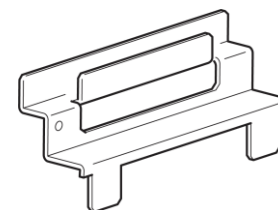

Cooling tray

## Getting started

① Open the battery slot cover located at the bottom of the splicer and insert the battery pack. Close and lock the cover.

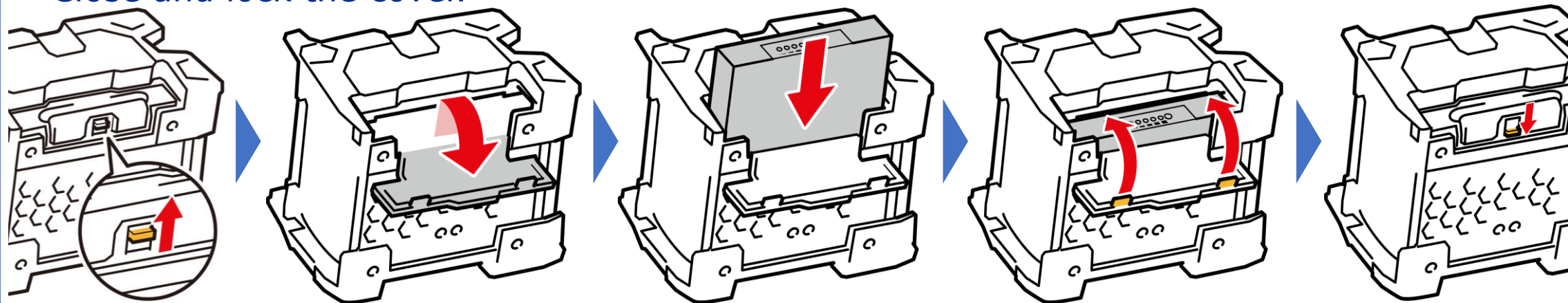

② Connect the AC adapter to the splicer to charge the battery pack.

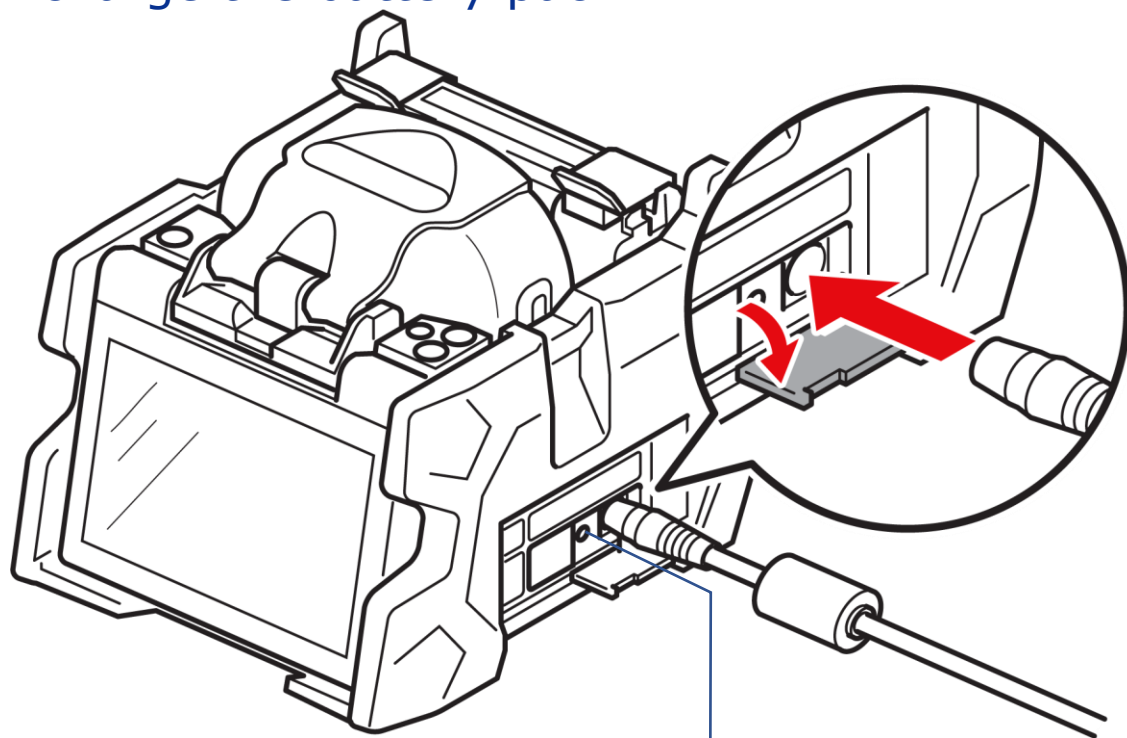

How to check battery capacity left

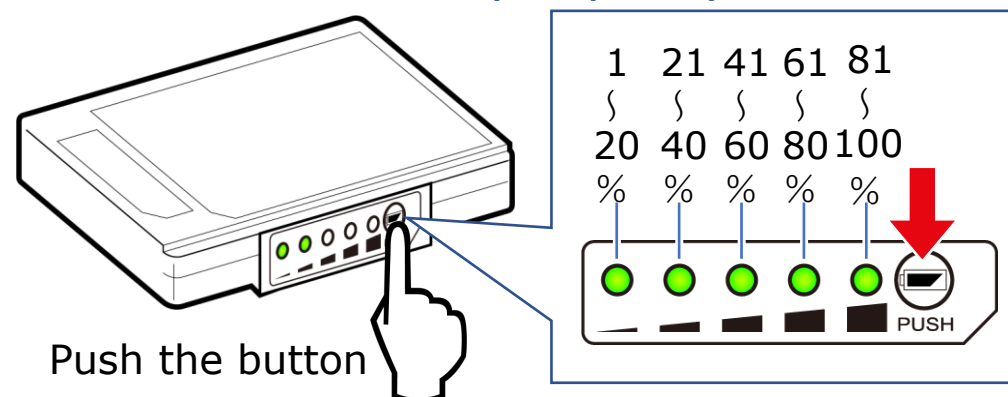

③ Press the POWER key.

④ The splicer turns on.

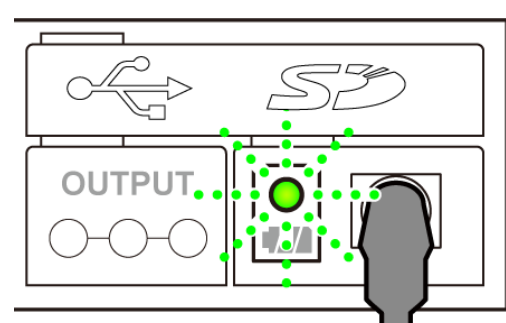
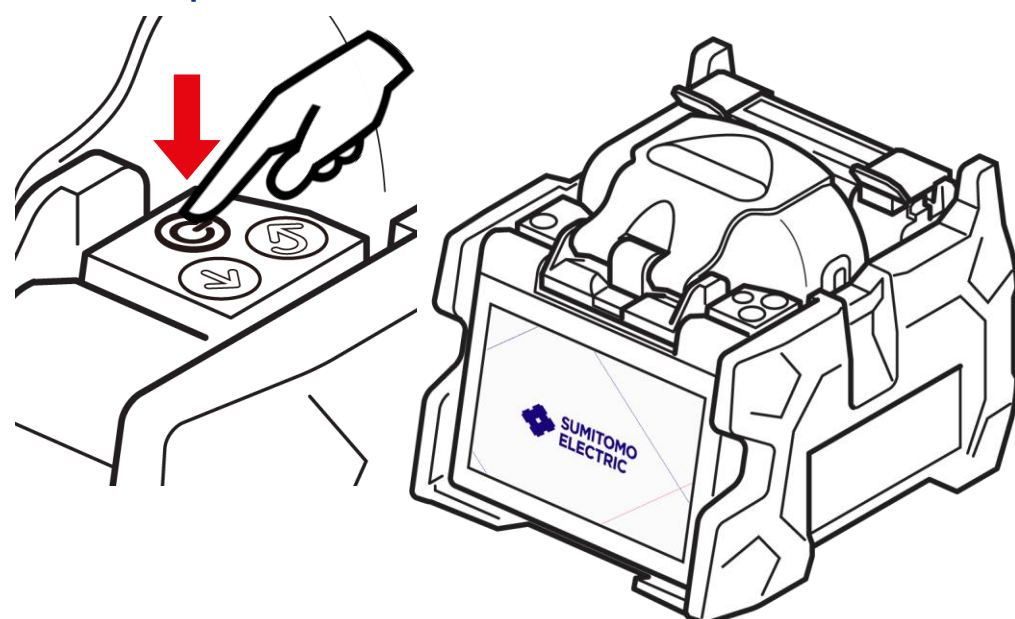

Charging (blinking)

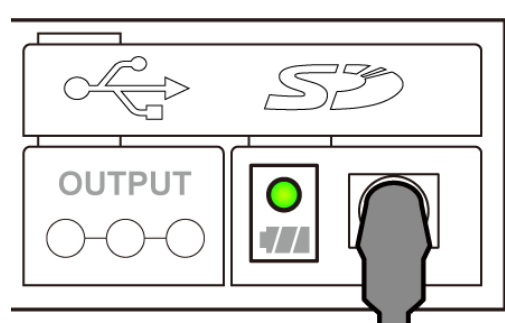

Fully charged (steady glow)

5 The splicer shows thumbnails of tutorial videos.



6 Tap the thumbnail to play the video.

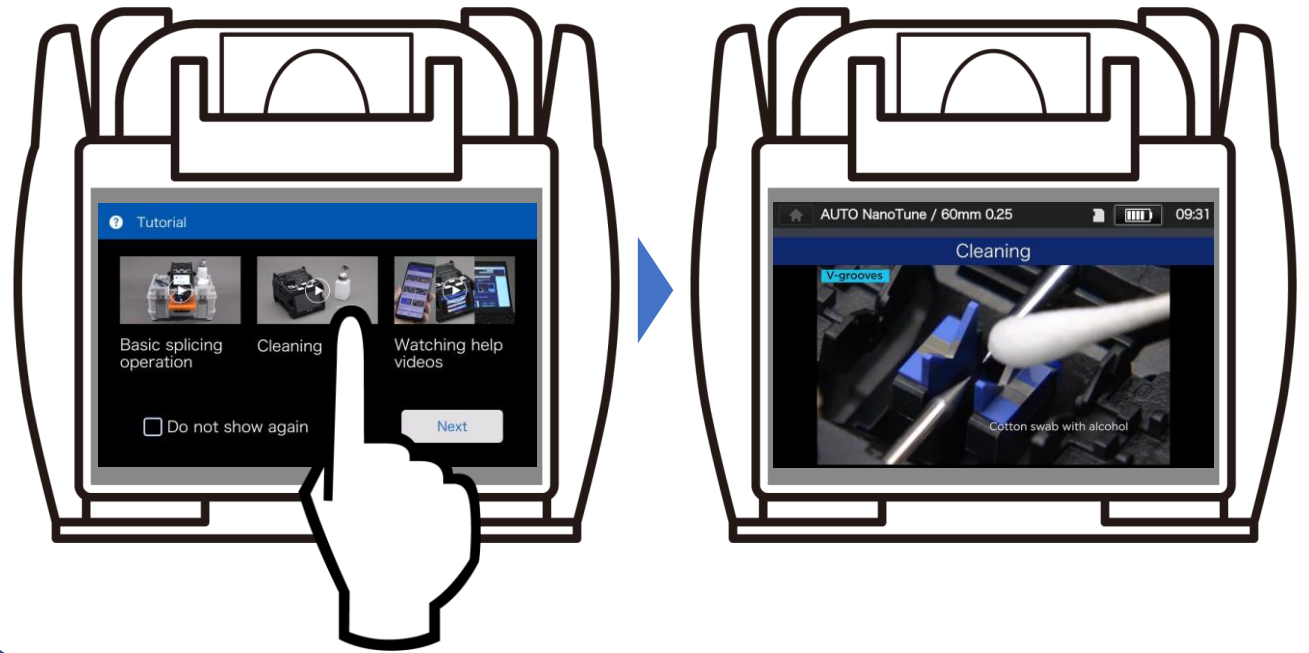

## Utilizing Help Videos

On the splicer



Also available online



### Video contents

#### Basic operation



Inserting the fibers into the splicer



Splice protection



V-grooves



Heat shrink oven

#### Consumables



Replacing the electrodes

#### Software update



On a computer

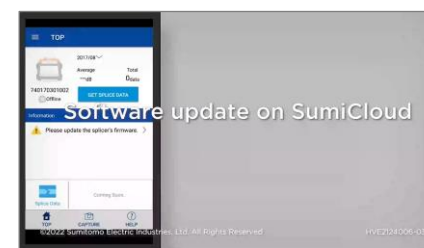

On SumiCloud

... and more in the list.

